



Lindab **Roof Drainage System**

Lindab Rainline™

Technical Information



Dimensioning

Roof drainage

Dimensioning can be done according to Swedish Standard SS or the Advice and instructions for the code of practice, "Hus AMA, RA 08 Hus".

Dimensioning to SS gives smaller dimensions than if RA 08 Hus is used. This

is because RA 08 Hus has given some consideration to the tendency of gutters to fill up with sludge from leaves and loose material on roof cladding etc. SS compensates this by specifying a smallest fall for self-clearance of 5-7 mm/m, depend-

ing on dimensions. Diagrams and tables based on the dimensioning instructions in SS and Hus AMA are included below.

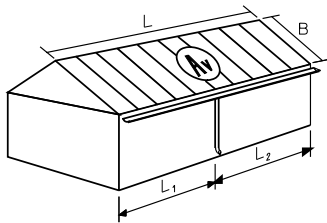

A_v = True roof area
 L_1 and L_2 = Distance from building corner

Example

Roof area $L = 20$ m, $B = 9$ m $\rightarrow A_v = 180$ m²
 A down pipe located 11.6 m from one end

$$\rightarrow \frac{L_1}{L_1 + L_2} = \frac{11.6}{20} = 0.58$$

Result

You can choose a half round gutter of R125 or larger.
 The down pipe from the second diagram should then be SRÖR75.

Dimensioning to SS

SS diagrams contain curves for various rain intensities. It approves the assumption that the probable rain intensity can be specified as 0.013 l / (sm²) on areas less than 10,000 m² for the whole country, which is what our diagram is based on. SS assumes that the gutter is laid with a smallest fall of 2.5 mm/m. Since SS does not cover our entire product range, the curves in SS have been extrapolated. It should be noted that the dimensioning instructions in SS can give a relationship between gutters and down pipes which does not correspond with the product standard for gutter outlets. This is because of traditional and appearance demands for size matching between gutters and down pipes.

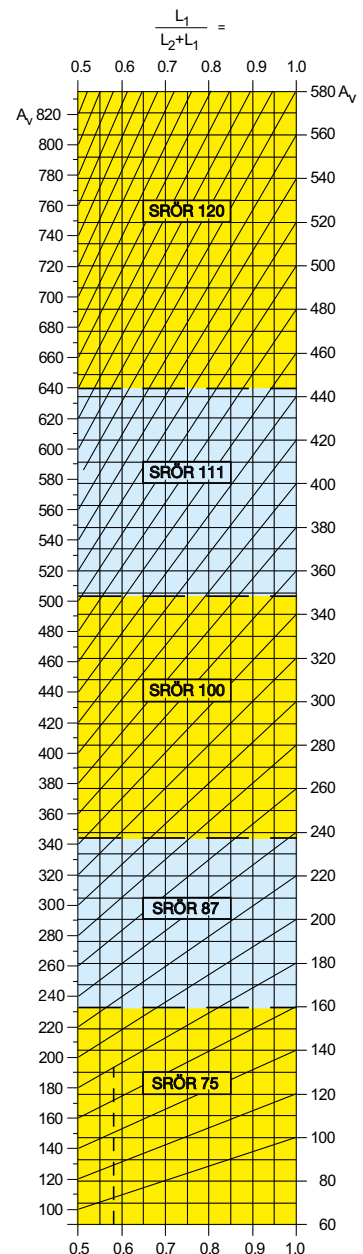
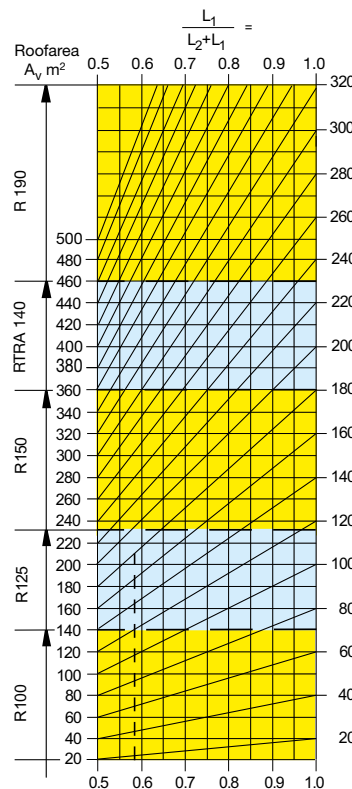

Technical Facts

Rainline*

Colour chart

Number	Name	Nearest NCS	Nearest RAL
001	Antique white	S 1002-G50Y	9002
015	Black	S 9000-N	9011
015	Black Matt	S 9000-N	9011
035	Graphite grey	S 7502-B	7016
035M	Graphite grey Matt	S 7502-B	7016
044	Anthracite metallic	-	9007
045	Silver metallic	-	9006
087	Dark grey	S 7005-B20G	7043
387	Coffee brown	S 8502-Y	8019
434	Brown	S 7010-Y70R	8017
434M	Brown Matt	S 7010-Y70R	8017
742	Tile red	S 4040-Y80R	8004
758	Dark red	S 5040-Y80R	3009



Hard to choose? With Lindab Rainline RAL you can get your new roof drainage system in a variety of 160 different RAL colors. This gives you great opportunities. Contact your Lindab sales team for more information.

All colour coated roof drainage products from Lindab are coated with a zinc layer of 275 g/m².

Aluminium

Number	Name	Nearest NCS	Nearest RAL
001	Antique white	S 1002-G50Y	9002
015	Black	S 9000-N	9011
035	Graphite grey	S 7502-B	7016
045	Silver Matt	-	9006

Other material

ALUZ	Aluminium-zink	-	-
ZM	Zinc-magnesium	-	-
CU	Copper	-	-

* All colors are not available in all dimensions and combinations.

Technical Facts

Gutter with accessories

R Gutter

Dim	D mm	d mm	Area* mm ²	Area** mm ²
100	107	17	4500	4100
125	123	17	5900	5500
150	155	17	9400	8900
190	192	22	17300	16200

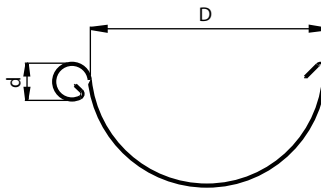

* Sectional area

** Water carrying area (6 mm lower front edge, 190 gutter 11 mm)

RSK Gutter joint

Dim
100
125
150

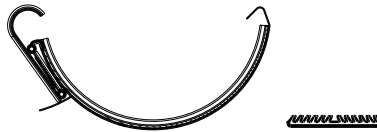

RSKR Gutter joint

Dim
125
150

To SS-EN 1462 Class A-H

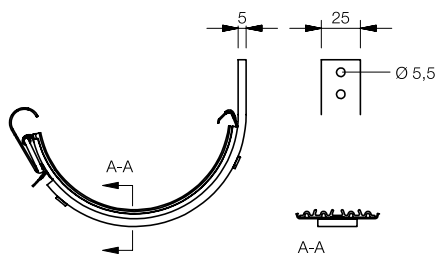

ARSK Gutter joint aluminium

Dim
125
150

To SS-EN 1462 Class A-H

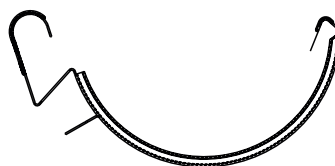

Technical Facts

Gutter with accessories

STAG Stay strap

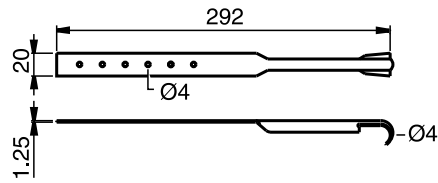

K33/K24/K18/K07 Bracket

Dim	L mm			
	K33	K24	K18	K07
100			180	70
125			180	70
150			180	70
190	334	244		74

To SS-EN 1462 Class A-H

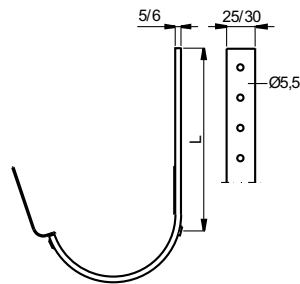

K11 Bracket for 27° roof pitch

Dim
100
125
150

To SS-EN 1462 Class A-H

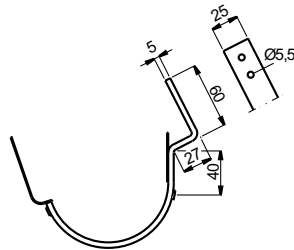

K11P 150 Bracket for Sandwich panels

Dim
150

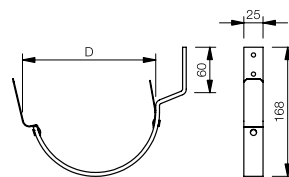

Technical Facts

Gutter with accessories

KFL35/KFL/KFM Bracket

Dim	L mm		
	KFL35	KFL	KFM
100		196	
125	336	196	146
150	336	196	146

To SS-EN 1462 Class A-H

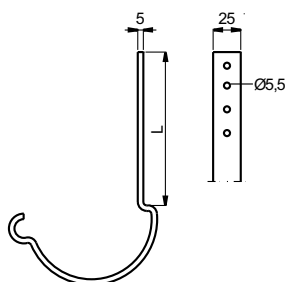

KFK Fascia Bracket

Dim
100
125
150
190

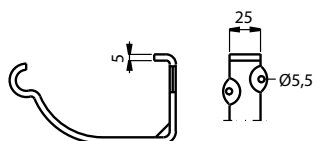

KRD Bracket

Dim
125

To SS-EN 1462 Class A-H

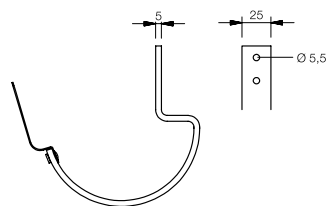

KRT Bracket

Dim
125
150

To SS-EN 1462 Class A-H

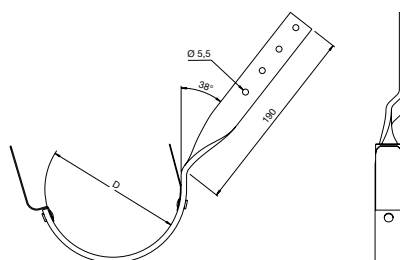

Technical Facts

Gutter with accessories

SKK Bracket

Dim	
100	
125	
150	

To SS-EN 1462 Class A-H

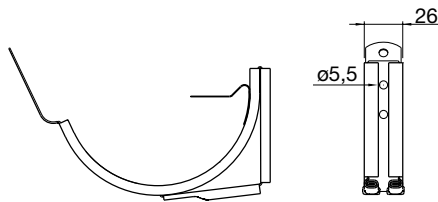

SKK05/SKK16/SKK21/SKK30 Bracket

Dim	L mm			
	SKK05	SKK16	SKK21	SKK30
100	70	160	210	300
125	70	160	210	300
150	70	160	210	300

To SS-EN 1462 Class A-H

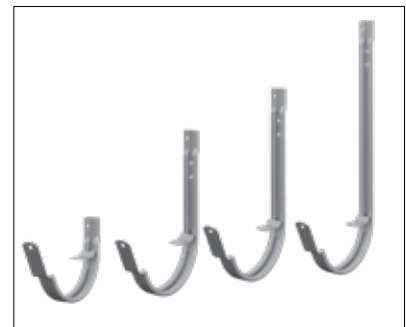
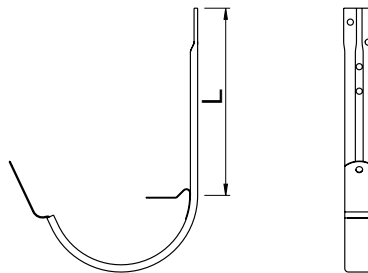

KBO Bracket bender



TB Cover brace

Dim	
100	
125	
150	

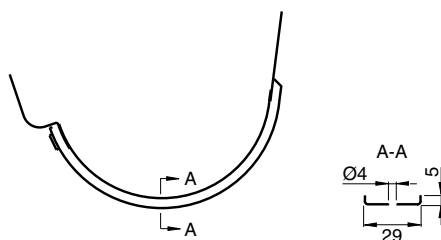

Technical Facts

Gutter with accessories

OMV Gutter outlet

Dim D/d	A mm	H mm
100/75	156	56
100/87	156	48
125/75	174	67
125/87	174	59
125/100	174	50
150/87	212	82
150/100	212	73
150/111	212	66
150/120	212	60

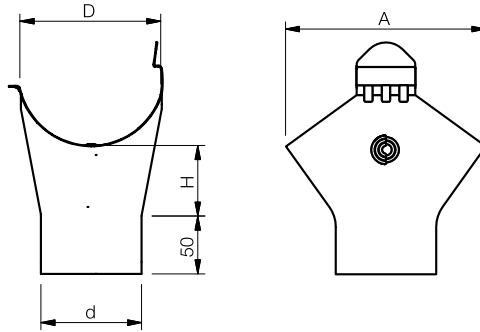

All gutter outlets in Cupper (CU) will be delivered as gutter outlet OK.

OK Gutter outlet

Dim D/d	A mm	H mm
150/75	194	55
190/100	180	62
190/120	206	62



RG Stop end

Dim
100
125
150

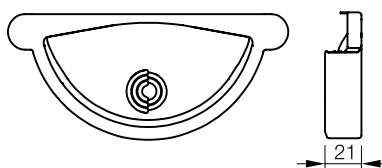

Technical Facts

Gutter with accessories

RGU Stop end

Dim	
100	
125	
150	

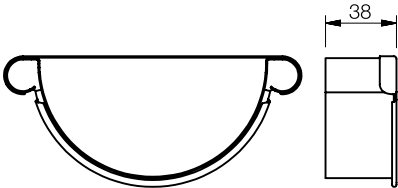

RGV/RGH Stop end

Dim	
190	

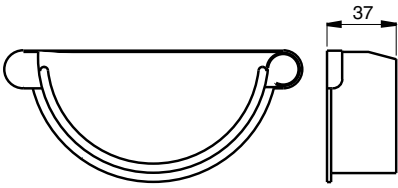

RVI Gutter angle, inner

Dim	L mm
100	400
125	300
150	300
190	500

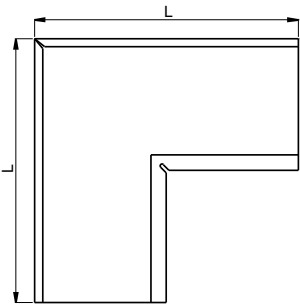

RVY Gutter angle, outer

Dim	L mm
100	295
125	160
150	130
190	285

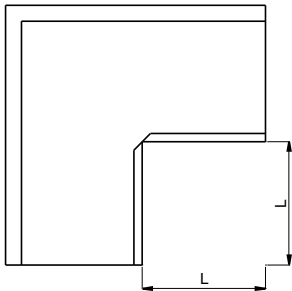

Technical Facts

Gutter with accessories

RVI135 Gutter angle 135°, inner

Dim	L mm
100	300
125	300
150	300

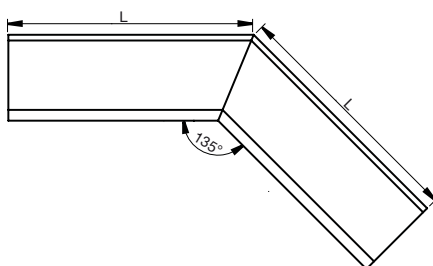

RVY135 Gutter angle 135°, outer

Dim	L mm
100	250
125	240
150	230

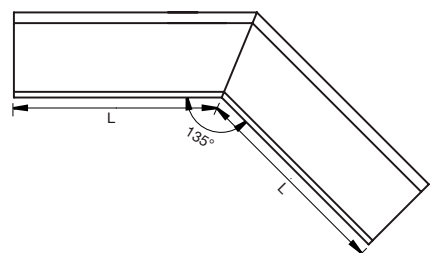

ÖSK Overflow protection

All dimensions

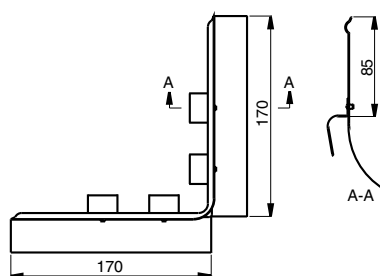

ÖSKR Overflow protection, straight

Dim
125
150

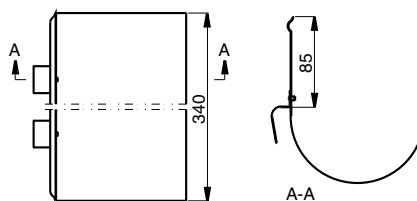

Technical Facts

Downpipe with accessories

SRÖR Down pipe

Dim	Area
Di/d	mm ²
75	4400
87	5900
100	7800
111	9700
120	11300

To SS-EN 612 Class A-X

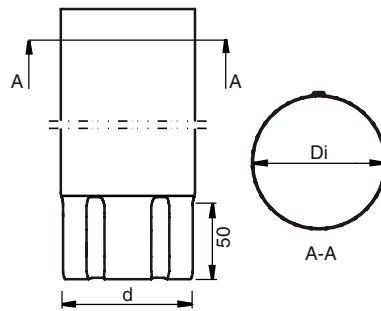

MST Intermediate pipe

Dim
75
87
100
111
120

Cut into suitable pieces

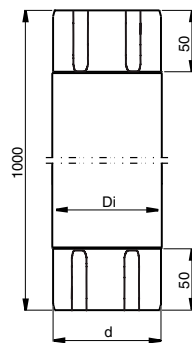

SRORM Pipe connector

Dim
D/d
75
87
100

SRORM fits both inside and outside the downpipe.

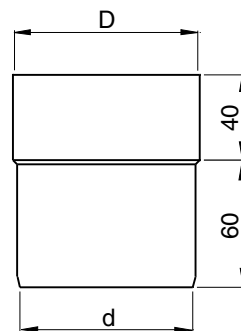

SOKN One piece bend

Dim
D/d
75
87
100

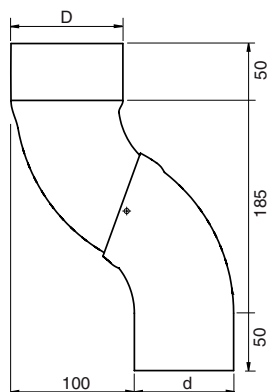

Technical Facts

Downpipe with accessories

BK45 Bends 45°

Dim	
Di/d	
75	
87	
100	

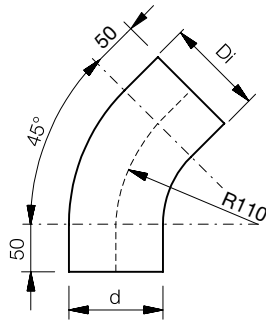

BM45 Bends 45°

Dim	
Di/d	
75	
87	
100	

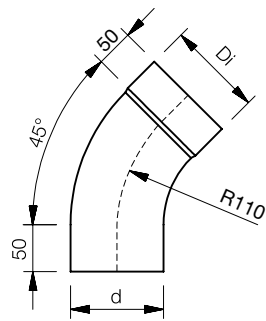

BK70 Bends 70°

Dim	
Di/d	
75	
87	
100	
111	
120	

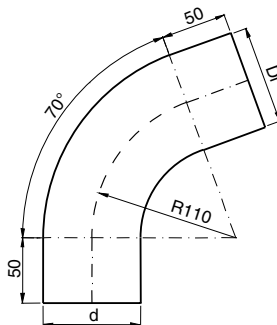

BM70 Bends 70°

Dim	
D/d	
111	
120	

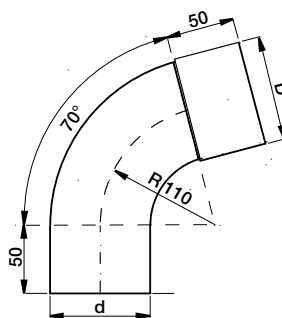

Technical Facts

Downpipe with accessories

BK85 Bends 85°

Dim	
Di/d	
75	
87	
100	

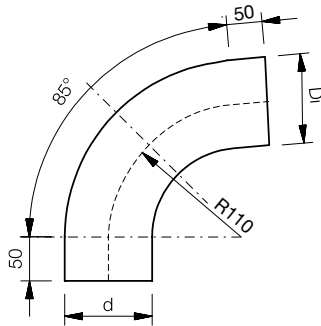

BM85 Bends 85°

Dim	
Di/d	
75	
87	
100	

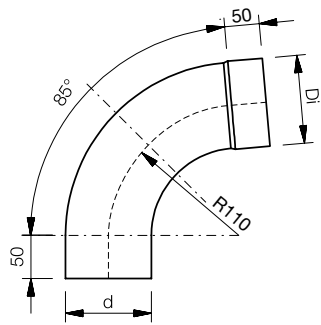

BKM70 Bends, conical 70°

Dim	
Di/d	
75	
87	
100	

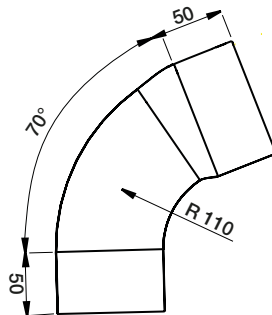

BKS Bends, sharp 70°

Dim	
D/d	
75	
87	
100	
111	
120	

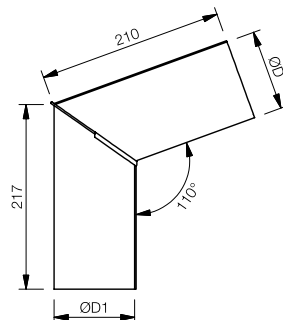

Technical Facts

Downpipe with accessories

SSVU Pipe holder

Dim	
D	
	75
	87
	100
	111
	120

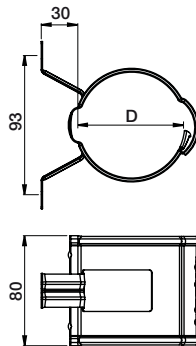

With wedge locking in aluminium-zinc and copper (CU) design.

SVHA Pipe holder

Dim	
D	
	75
	87
	100
	111
	120

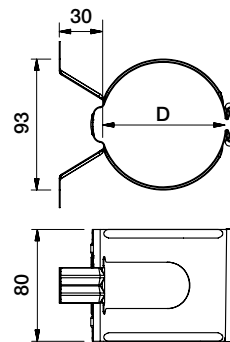

SV Pipe holder with spike

Dim	
D	
	75
	87
	100
	111
	120

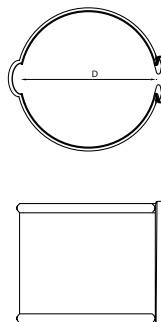

SST Spike

L	
mm	
	125
	175
	250
	300

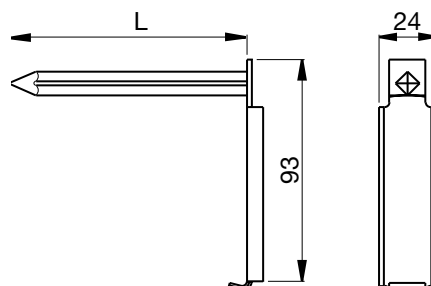

Technical Facts

Downpipe with accessories

SSC Screw kit

Distance from wall (mm)	Plug	Screw	Distances*
25	1	1	1
55	1	1	2
85	1	1	3
115	1	1	4

*Distances in light grey HD polythene



SHFS Pipe holder with screw

Dim D	L mm	
75	100	140
87	100	140
100	100	140

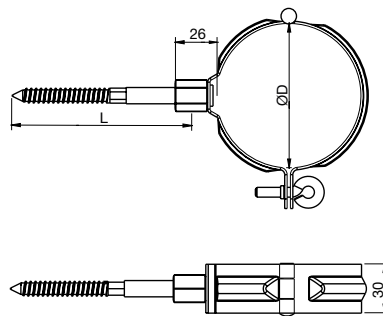

SHFB Pipe holder with legs

Dim D
75
87
100

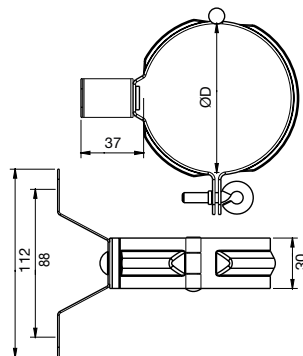

Technical Facts

Downpipe with accessories

VATK Hopper

Dim	h
87	270
100	253
111	239
120	227

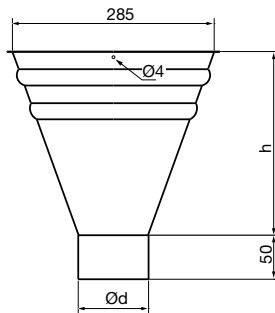

VATKL Square hopper

Dim	h
75	305
87	230
100	200

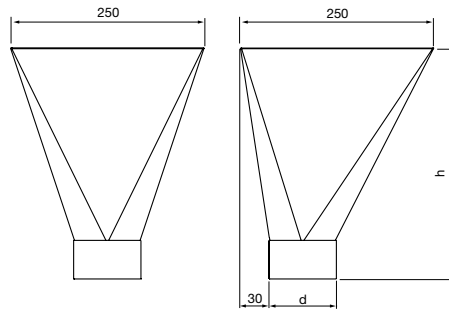

VATKS Halfround hopper

Dim	h
87	270
100	253

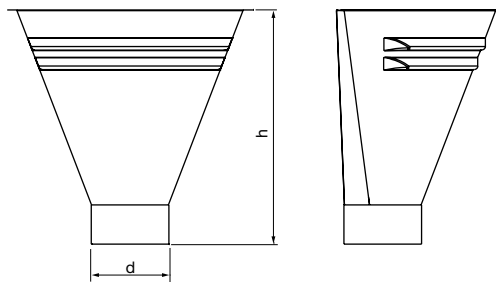

FRK Gutter hook

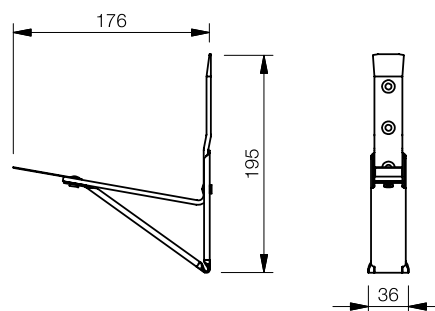

Technical Facts

Downpipe with accessories

GRÖR Adjustable branch

Dim	
75	
87	
100	
111	
120	

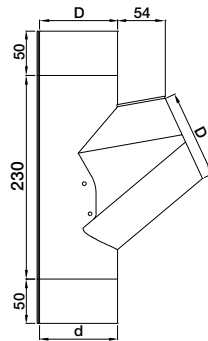

FUTK Adjustable shoe

Dim	
75	
87	
100	

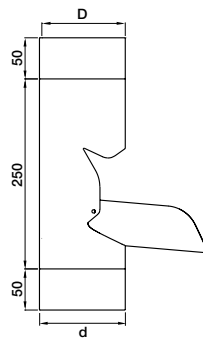

UTK Shoe

Dim	L mm
75	151
87	157
100	113
111	169
120	173

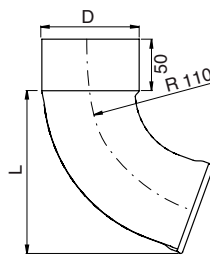

UTKS Shoe, sharp

Dim	
75	
87	
100	
111	
120	

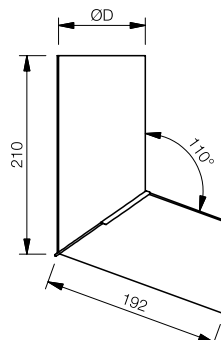

Technical Facts

Downpipe with accessories

SLAS

Connector for 80 mm hose.

Dim

87

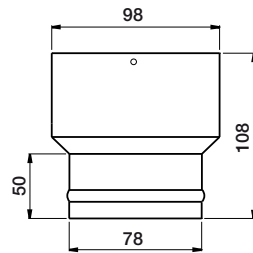

BUTK Drain shoe

Dim	D1 mm	D2 mm
75	81	115
87	93	115
100	93	115
111	93	119
120	93	125

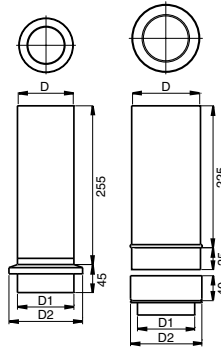

DVSIL Leaf filter

Stainless steel.

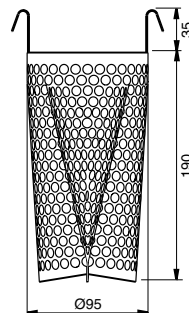

PRT Sliding pipe

Dim

75

87

100

111

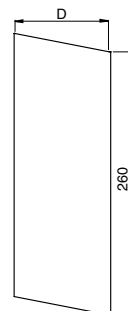

The sliding pipe fits outside the downpipe.

Technical Facts

Downpipe with accessories

RT Drain trap (HD polythene)

Leaf filter in HD polythene for downpipes.
The lower section fits standard ground pipes/ junction pipes.

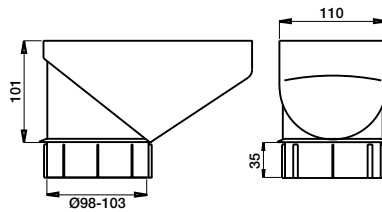

SLS Self cleaning leaf trap

Self cleaning leaf filter in HD polythene for downpipes. The lower section fits standard ground pipes.

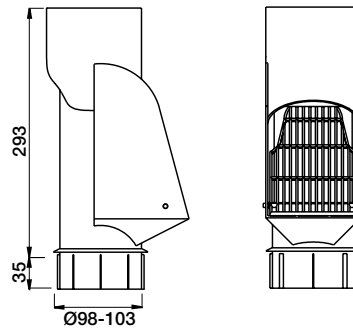

MRT Drain connector

Connector for HD polythene filters.
For connection to ground pipes with dimensions other than standard.

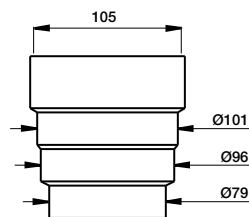

IMR Lining of the cursor

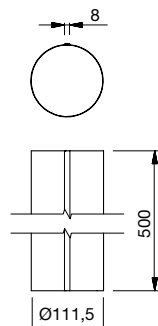

Technical Facts

Reinforced downpipe with accessories

VANSLS 300

300 mm reinforced self-cleaning leaf filter.

	Steel	Stainless
Outer dim. (Ø mm)	101.6	101.6
Thickness	2.0	1.5
Weight (kg)	2.1	1.8

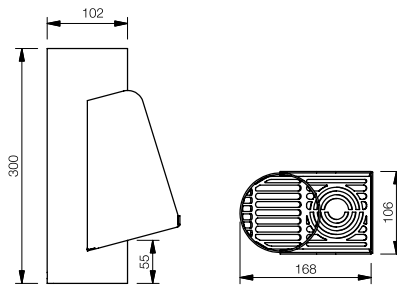

VANSLS 850

830 mm reinforced downpipe with self-cleaning leaf filter for buildings with plinth.

	Steel	Stainless
Outer dim. (Ø mm)	101.6	101.6
Thickness	2.0	1.5
Weight (kg)	5.3	4.1

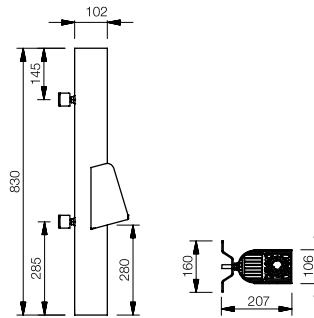

VANUTK 850

850 mm reinforced downpipe with shoe.

	Steel	Stainless
Outer dim. (Ø mm)	101.6	101.6
Thickness	2.0	1.5
Weight (kg)	5.3	4.0

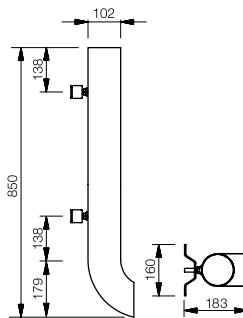

VANSLS 2000

2m reinforced downpipe with self-cleaning leaf filter at the bottom.

	Steel	Stainless
Outer dim. (Ø mm)	101.6	101.6
Thickness	2.0	1.5
Weight (kg)	10.9	8.5

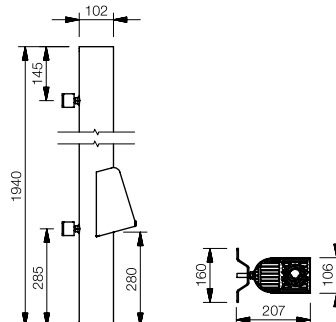

Technical Facts

Reinforced downpipe with accessories

VANSLST 2000

2m reinforced downpipe with self-cleaning leaf filter on top. Excellent for use in kindergarten and junior school environments.

	Steel	Stainless
Outer dim. (Ø mm)	101.6	101.6
Thickness	2.0	1.5
Weight (kg)	10.9	8.5

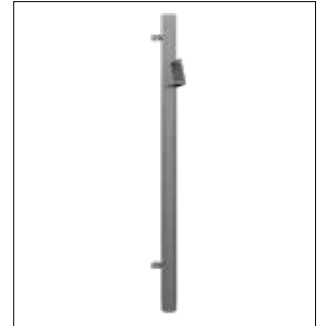
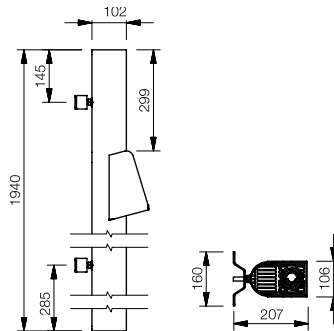

VANUTK 2000

2m reinforced downpipe with shoe.

	Steel	Stainless
Outer dim. (Ø mm)	101.6	101.6
Thickness	2.0	1.5
Weight (kg)	11.8	8.0

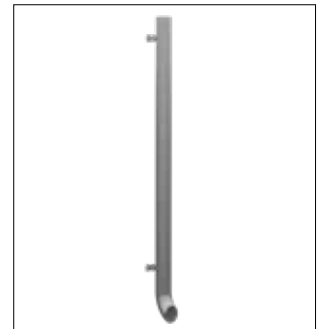
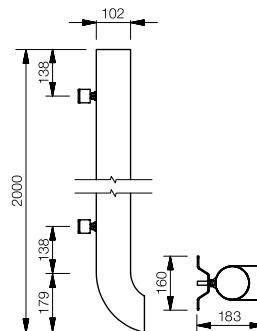

VANSTD 2000

	Steel	Stainless
Outer dim. (Ø mm)	101.6	101.6
Thickness	2.0	1.5
Weight (kg)	10.5	8.2

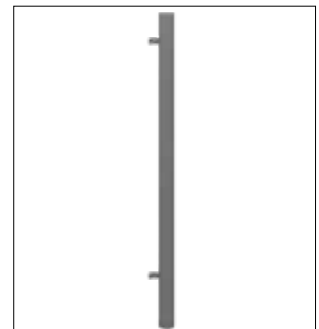
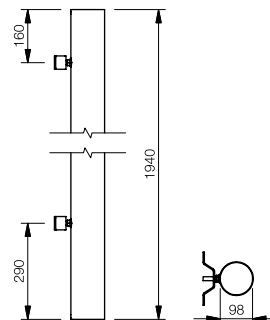

Technical Facts

Rectangular gutter with accessories

RTRA Gutter

Dim	Area* mm ²
140	10 000

* Water carrying area.

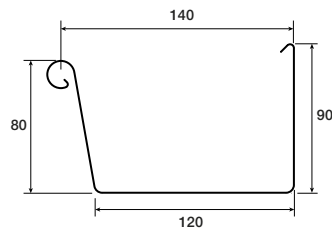

RTSK Gutter joint

Dim
140

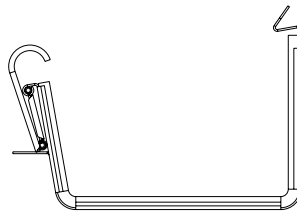

RTGV/RTGH Stop end

Dim
140

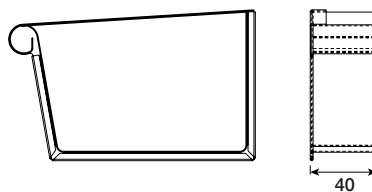

RTK07/RTK21 Bracket

Dim	L mm	
	RTK07	RTK21
140	70	210

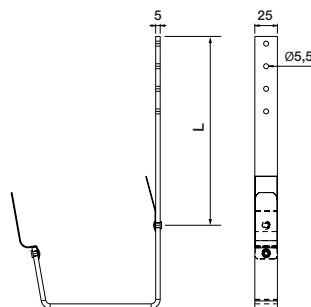

Technical Facts

Rectangular gutter with accessories

RTKFK Bracket

Dim	
140	

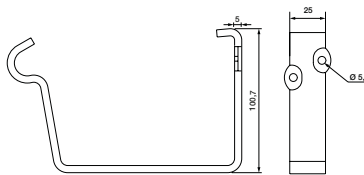

RTOK Gutter outlet

Dim	H
D/d	mm
140/87	95
140/100	85
140/111	75

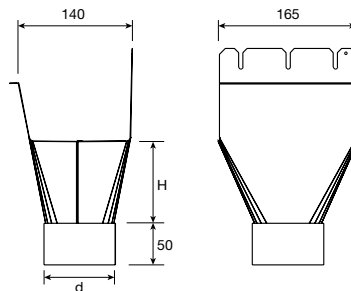

RTVI Gutter angle, inner

Dim	
140	

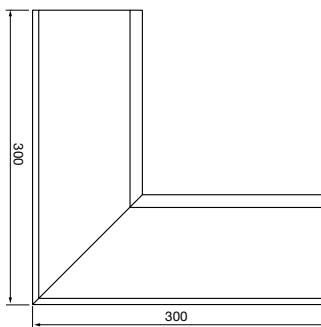

RTVY Gutter angle, outer

Dim	
140	

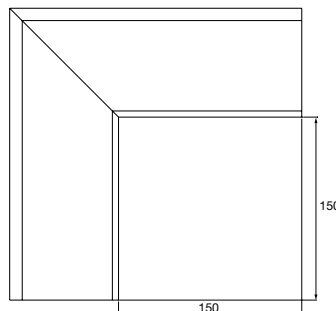

Technical Facts

Quarter round gutter with accessories

KVRA Gutter

Dim	Area*	Area**
	mm ²	mm ²
130	13 269	11 969

* Sectional area

** Water carrying area (10 mm lower front edge)

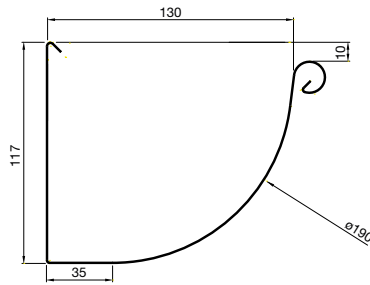

KVSK Gutter joint

Dim
130

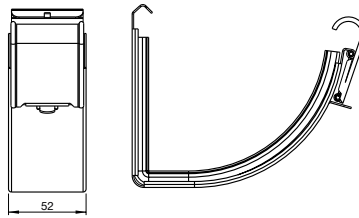

KVK07 Bracket, short

Dim
130

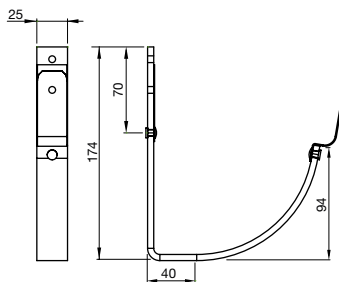

KVK21 Bracket, long

Dim
130

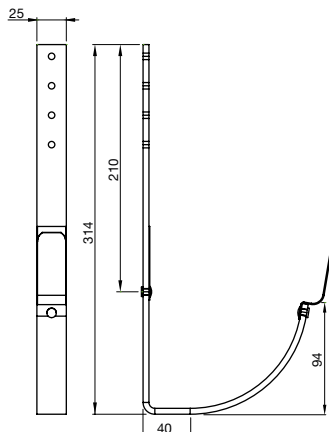

Technical Facts

Quarter round gutter with accessories

KVFK Bracket, short

Dim	
130	

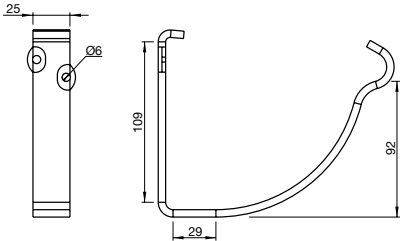

KVTP Gutter outlet

Dim	H
D/d	mm
130/87	88
130/75	75

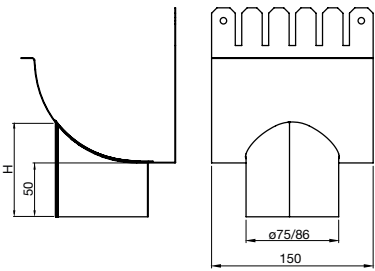

KVGV/KVGH Stop end

Dim	
130	

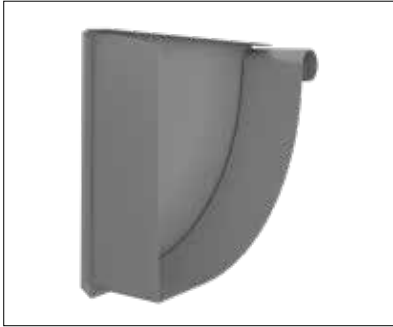
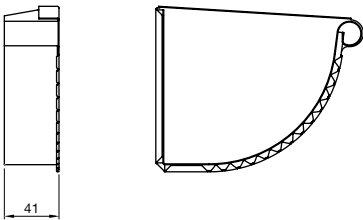

Technical Facts

Quarter round gutter with accessories

KWVI Gutter angle, inner

Dim _____
 130 _____

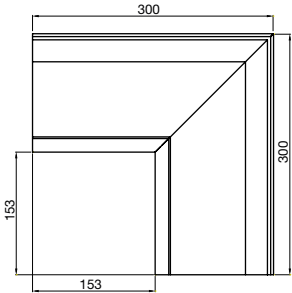

KVY Gutter angle, outer

Dim _____
 130 _____

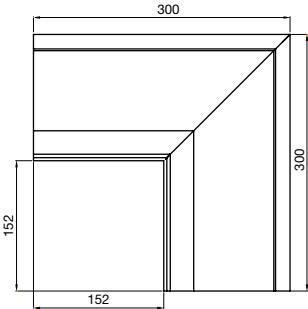

KWVI Gutter angle, inner 135°

Dim _____
 130 _____

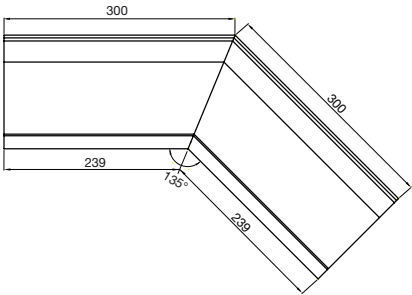

KVY Gutter angle, outer 135°

Dim _____
 130 _____

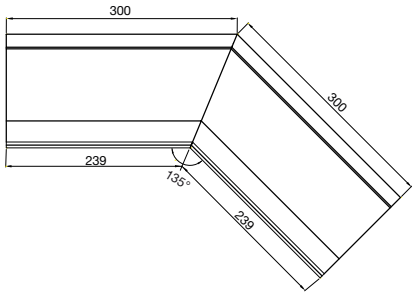

Technical Facts

Accessories

STIFT Touch up paint

Touch up paint to fix the small scratch or to cover up cut ends, with application brush.





Most of us spend the majority of our time indoors. Indoor climate is crucial to how we feel, how productive we are and if we stay healthy.

We at Lindab have therefore made it our most important objective to contribute to an indoor climate that improves people's lives. We do this by developing energy-efficient ventilation solutions and durable building products. We also aim to contribute to a better climate for our planet by working in a way that is sustainable for both people and the environment.

[Lindab | For a better climate](#)